

FAG

**53244-MP**

Axial deep groove ball bearing

Schaeffler ID:  
0392565370000Axial deep groove ball bearing 532..-MP,  
single direction, with spherical housing  
washer, solid brass cage

## Technical information

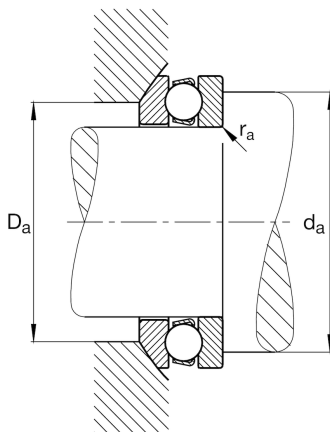
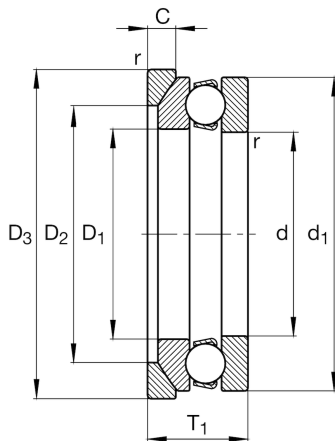
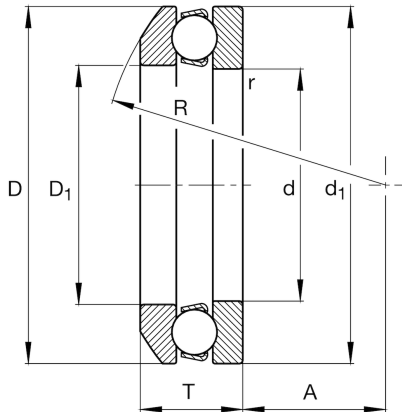
**Main Dimensions & Performance Data**

d	220 mm	Inner diameter shaft washer
D	300 mm	Outer diameter housing washer
T	65,6 mm	Height
$C_a$	335.000 N	Basic dynamic load rating, axial
$C_{0a}$	1.330.000 N	Basic static load rating, axial
$C_{ua}$	37.500 N	Fatigue load limit, axial
$n_G$	1.420 1/min	Limiting speed
$n_{gr}$	1.690 1/min	Reference speed
	1 g	Weight

**Dimensions**

$r_{min}$	2 mm	Minimum chamfer dimension
$D_1$	224 mm	Inner diameter housing washer
$d_1$	295 mm	Outer diameter shaft washer
R	225 mm	Radius spherical housing washer
A	118 mm	Distance of the center point
$T_1$	75 mm	Height with seat washer

**Mounting dimensions**

$d_{a min}$	268 mm	Minimum diameter shaft shoulder
$D_{a max}$	260 mm	Maximum diameter of housing shoulder
$r_{a max}$	2 mm	Maximum filled radius

**Calculation factors**

A	9,6	Minimum load factor
---	-----	---------------------

**Additional information**

U244	Seat washer
------	-------------

**Temperature range**

$T_{min}$	-30 °C	Operating temperature min.
$T_{max}$	200 °C	Operating temperature max.

